

SMA364A-0000

SMA Plug For Panel Receptacle 50Ω

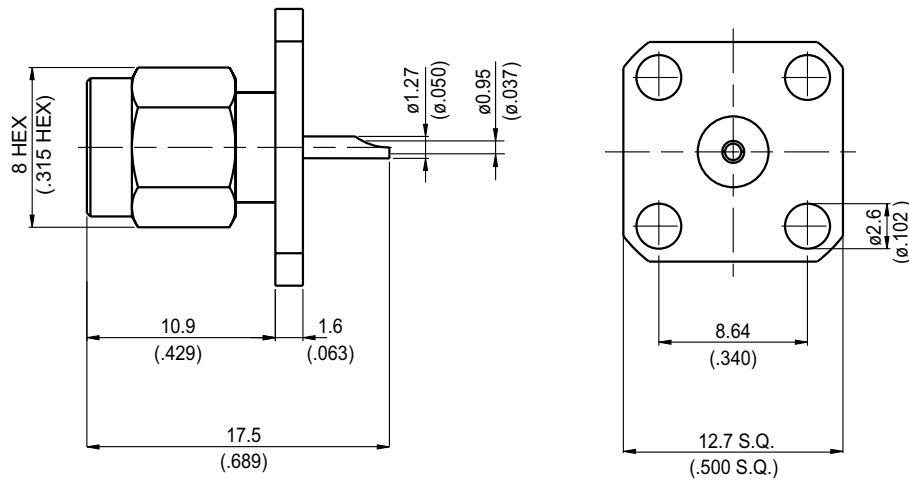

Parts	Material	Plating (Micro-inch)
Renber Ring	Beryllium Copper	Tin-Zinc-Copper-Alloy 100 Over Copper 50
Gasket	Silicon	
Contact Pin	Brass	Gold 20 Over Nickel 50 Over Copper 50
Insulator	Teflon	
Body	Brass	Gold 5 Over Nickel 50 Over Copper 50
Coupling Nut	Brass	Gold 5 Over Nickel 50 Over Copper 50

Weight: 4.10 g

This part number complies with RoHS.

Notice: JYEBAO reserves the right to make modifications deemed appropriate.