

SMA864P-0000

SMA Jack For Panel Receptacle 50Ω

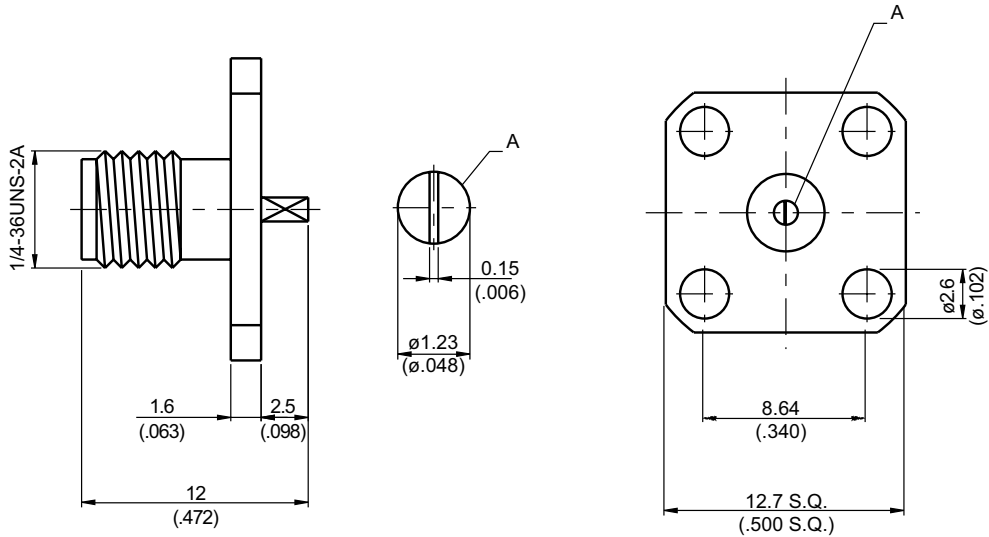

Parts	Material	Plating (Micro-inch)
Contact Pin	Beryllium Copper	Gold 20 Over Nickel 50 Over Copper 50
Insulator	Teflon	
Body	Brass	Gold 5 Over Nickel 50 Over Copper 50

Weight: 2.82 g

This part number complies with RoHS.

Notice: JYEBAO reserves the right to make modifications deemed appropriate.